

# iSOLAR

powered by **ICON**

## PDP SERIES

4" Helical Solar Pump



BIA-PDP4 Solar 900 - 808695

BIA-PDP4 Solar 1200 - 808696

BIA-PDP4 Solar 1500 - 808697



\*iSOLAR V3 controller  
Item code: 805989

OR



\*iSOLAR Pro controller  
Item code: 805893

iSOLAR V3 or Pro Controller must be used with motor.  
\*Controller not included with pump purchase

# 1. Contents

<b>1. Contents</b> .....	<b>2</b>
<b>2. Glossary</b> .....	<b>2</b>
<b>3. Introduction</b> .....	<b>3</b>
<b>4. ISO 7010 Symbols used in this manual</b> .....	<b>3</b>
<i>SECTION ONE – Specifications and Features</i> .....	<b>4</b>
<b>5a. iSOLAR Motor features and specifications</b> .....	<b>4 - 6</b>
<i>SECTION TWO – Installation Guide</i> .....	<b>7</b>
<b>6a. Warnings and Cautions before starting</b> .....	<b>7</b>
<b>6b. Solar array installation</b> .....	<b>8 - 9</b>
<b>6c. iSOLAR V3 Controller installation notes</b> .....	<b>10</b>
<b>6d. Electrical Connections</b> .....	<b>10</b>
<b>6e. Controller Operation</b> .....	<b>11</b>
<b>6f. iSOLAR PDP4 pump installation notes</b> .....	<b>12 - 15</b>
<b>6g. Cable Jointing</b> .....	<b>16</b>
<i>SECTION THREE – Pump operation</i> .....	<b>17</b>
<b>7a. Operation summary and commissioning</b> .....	<b>17 - 18</b>
<i>SECTION FOUR – Troubleshooting</i> .....	<b>19</b>
<b>8a. Trouble shooting - Overview</b> .....	<b>19 - 21</b>
<b>8b. Trouble shooting chart</b> .....	<b>22</b>
<b>9. Warranties – Terms and Conditions</b> .....	<b>23</b>

# 2. Glossary

<b>Term</b>	<b>Definition</b>
Voc (V)	Volts - open circuit, nothing connected
Vmpp (V) or Vmp	Volts - maximum power point, under load
Isc (A)	Amps - short circuit
Impp (A) or Imp	Amps - maximum power point
DC Power in W	Vmp x Impp

### 3. Introduction

Welcome to the iCON iSOLAR revolution!





The 4" Helical Rotor iSOLAR PDP4 increases the scope and flexibility of the iSOLAR product suite. Employing the same proven, highly efficient and innovative iSOLAR M220HR motor, the addition of a progressive cavity helical rotor wet end exploits the versatility of the motor's operating range to deliver water even when solar conditions are less than optimum.

The iSOLAR 4" PDP can be installed down a bore, in a tank or fitted to a pontoon to supply from an open body of water.

No more external energy costs! Just harvest the sun to move your water.

Progressive Cavity / Helical Rotor pumps can produce extremely high pressures and all electrical energy must be treated with care. Stay safe and get the important details right so you can enjoy the benefits of your purchase for many years to come.

### 4. ISO 7010 Symbols used in this manual

	Warning - Electrical safety
	Warning – Potential consequences of use outside of intended application(s). Includes environmental condition warnings.
	Mandatory warning
	Warning to disconnect power
	Read carefully

# SECTION ONE – Specifications and Features

## 5a. iSOLAR Motor features and specifications

The iSOLAR M220HR is a truly innovative rare earth, permanent magnet motor design which can be powered with either AC or DC power.

The motor has an internal two stage electronic frequency converter and electronic motor management programmed with MPPT and Vector control logic to select the best operating point for the pump, based on the input energy available. The motor speed will vary from 0 to 3600 rpm depending on the load and available power input to deliver water in the most efficient manner.

A helical rotor provides better system efficiency, more suitable for small flows and high head applications. The stator is a special wear resistant rubber developed for Australasian conditions with a chrome plated screw (rotor).

- Performance and service life of the system will be seriously reduced in water containing a sand loading greater than 100g/m<sup>3</sup>.
- Water temperature has an impact on pump performance. Recommended water temperature of 10° to 40° C.
- Maximum axial thrust 3000N.
- The maximum submergence depth is 150m.

**The iSOLAR Motor internal electronics are capable of the following functions:**

- |  |                                |
|--|--------------------------------|
| 1. Accepts AC or DC power              | 8. Over-current protection     |
| 2. MPPT (maximum power point tracking) | 9. Lost-Phase protection       |
| 3. Vector control                      | 10. Missing-voltage protection |
| 4. Dry run protection                  | 11. Over-power protection      |
| 5. Reverse protection                  | 12. Low voltage protection     |
| 6. Over-head protection                | 13. Stall protection           |
| 7. Over-load protection                |                                |

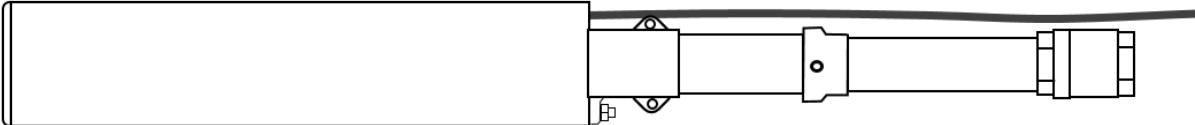

Dry run protection is provided by the mandatory fitment of a low-level water float included with each pump.

**iSOLAR M220HR Motor Input Energy Limitations**

Voltage	Current	
60 – 380Vmp 60 - 440Voc	12 Amp DC (Isc)	Direct Current i.e. Solar
90 – 280V AC Single Phase	10 Amp AC	Alternating Current i.e. Generator or Mains Supply

## 5b. V3 Controller functions and specifications

The iSOLAR M220HR motor can operate connected directly to a suitable power source. The motor internal electronics provide some level of control and protection. The motor runs when energy is available. In this state there is NO control over when the motor runs.

Used in conjunction with the V3 controller, the system has greater levels of protection and additional functions which increase convenience for the user while improving the reliability and durability of the pump. It has a display which shows the motor power consumption.

When an alternative power source is available the controller can switch from AC to DC and back. Connected to a compatible auto-start generator, the controller will manage the generator operation automatically. **Contact White International for details.**

The controller enables connection of external control devices such as floats or pressure switches to automatically maintain tank levels or stop the pump when no water is available. Primarily, the controller prevents the motor from starting excessively.



The V3 controller is weather-proof (IP65) and intended for outdoor use. Installation in direct sunlight, however, should be avoided.

### V3 Controller functions

- Manual pump switching ON / OFF
- Three modes of operation
  - AC MODE: power supplied from a Generator or Mains power
  - DC MODE: power supplied from a Solar Array or Battery storage
  - AUTO MODE: Automatic switching from DC to AC
- LED indication of Power On, Pump On, Pump Off
- LED Indication of operation interruption
- Motor power consumption display
- Over-voltage protection
- Automatic start and stop of a compatible generator (contact White International for details of this option)



### V3 Controller specifications



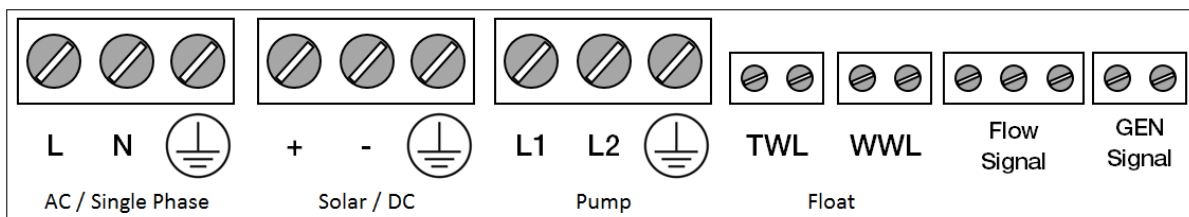





- The V3 Controller is designed, developed and manufactured for use with the iSOLAR motor only
- AC and DC compatible
  - AC voltage input range Single phase 90 – 280 VAC.
  - DC voltage input range 60 – 380 Vmpp/440Voc.
- Accepts up to 3 inputs



# Notes:

## SECTION TWO – Installation Guide

### 6a. Warnings and Cautions before starting

	<p>Please read the manual fully and carefully before starting. Retain the manual for future reference.</p>
	<p>Any changes or modification to the wiring must be carried out by competent, skilled and suitably qualified personnel only.</p>
	<p>Solar panels create electrical energy when exposed to light. Always treat solar panels as live and handle with care.</p>
	<p>The iSOLAR PDP4 motor has internal capacitors that <b>MUST</b> be allowed to discharge before handling. Allow 2 minutes for stored energy to dissipate before handling the pump/motor.</p>
	<p>Never open the cover while controller is connected to an electrical supply. Disconnect and allow 2 minutes for the internal electronics to discharge before opening the cover.</p>
	<p>The controller is IP65 rated but should not be exposed to direct sunlight. Install the controller where it has excellent ventilation away from direct sunlight or exposure to adverse weather.</p>
	<p>Solar arrays are an attractive earth path for lightning strikes. Ensure the panels and controller are well earthed.</p>
	<p>Helical rotor pumps must be used in a clean water, sediment-free environment. Even a small amount of sand may lead to screw wear, jamming or performance degradation.</p>
	<p>This appliance is not intended for use by persons (including children) with reduced physical, sensory or mental capabilities, or lack of experience and knowledge, unless they have been given supervision or instruction concerning use of the appliance by a person responsible for their safety. Children should be supervised to ensure that they do not play with the appliance.</p>

## 6b. Solar array installation

The power supply from a DC power source such as solar panels can cause **SERIOUS HARM** or **DEATH** from electrocution



- Use appropriate safety procedures when working on any system component
- Only suitable qualified personnel should carry out electrical connection/disconnection
- Off-grid electrical equipment is subject to applicable regional and national electrical standards
- Always treat solar panels as LIVE and handle with care
- Use correctly rated electrical cable and connectors

Solar Panels and their mounting systems (where applicable) are supplied separately and with their own instructions for positioning and assembly.

Always connect the solar panels in series respecting the Max VOC and Max Amperage of the motor and controller Excessive voltage or current can cause serious harm or irreparable damage voiding warranty.

**DC Volts: 60 to a Maximum of 380 Vmpp / 60 - 440 Voc**  
**DC Amps Max 12A ISC**

**AC Volts: 90 to a maximum of 280 Volts single phase**  
**AC Amps Max 10A**

Connecting solar panels in Series results in the following:

- Output Wattage multiplies by the number of panels
- Output Voltage multiplies by the number of panels
- The Output Amperage remains the same as a single panel

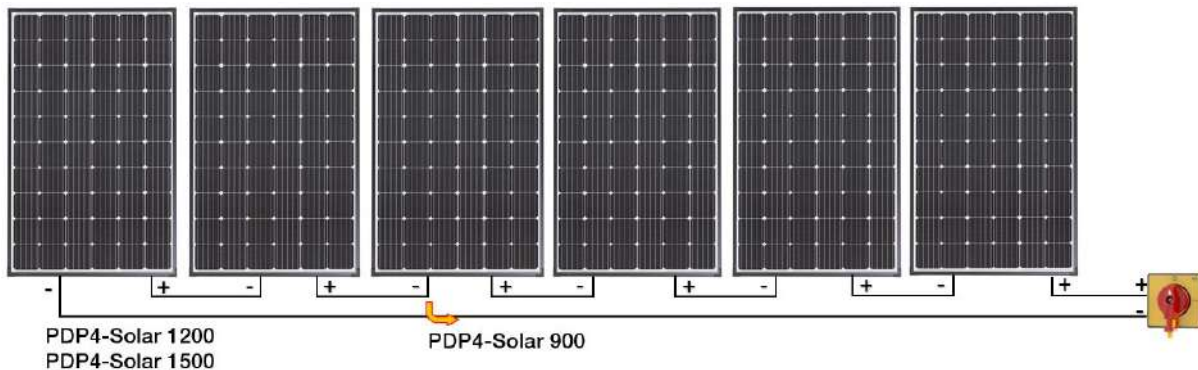

Example panel spec: *310W Panel, 40.3 Voc, 33.4 Vmpp, Impp 9.58A, Isc 10.2 A*

4 panels in series:

$4 \times 310W = 1240W$ ,  $4 \times 40.3Voc = 161.2 Voc$ ,  $4 \times 33.4 Vmp = 133.6 Vmp$ ,  $10.2 A Isc$

6 panels in series:

$6 \times 310W = 1860W$ ,  $6 \times 40.3Voc = 241.8 Voc$ ,  $6 \times 33.4 Vmp = 200.4 Vmp$ ,  $10.2 A Isc$

Adding more panels can effectively extend the length of the pumping day however the pump output is constrained by the wet-end design and maximum pump motor rpm.



## 6b. Solar array installation cont.

### **SOLAR ARRAY**

- The Solar array must face True North.
- The solar panel angle should correspond to the latitude of the site. Consult the instructions supplied with the solar array to assist your decision regarding the best angle for your situation.

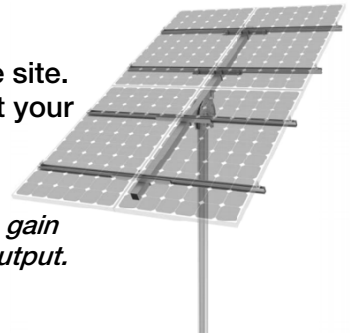

*As a rule of thumb, solar panels should be more vertical during winter to gain most of the low winter sun, and flatter during summer to maximize the output.*

- Protect the array and controller from stock.
- Any shading whatsoever will reduce the solar panel(s) performance so locate the panels with this in mind. Panel shadowing is like “open circuiting” a panel.
- Dust or bird droppings will impair the array energy output. Keep panels clean.
- Ensure the array is earthed to ground in the event of lightning strike

To minimise energy losses the following chart provides recommended cable sizes. If calculating your own cable size, maximum voltage drop allowable is 3%.

Solar Panel Input (In Series)			Cable length - up to 'X' meters									
DC Input Power Watts	Vmpp Volts	Imp Amps	10	25	50	75	100	125	150	200	250	300
			Cable cross section mm <sup>2</sup>									
2 of 640W	66.8	9.58	2.5	6	10	25	25	35	35	50	70	70
3 of 960W	100.2	9.58	1.5	4	10	16	16	25	25	35	50	50
4 of 1280W	133.6	9.58	1.5	4	6	10	16	16	25	25	35	35
5 of 1600W	167.0	9.58	1.5	2.5	6	10	10	16	16	25	25	35
6 of 1920W	200.4	9.58	1.5	2.5	4	6	10	10	16	16	25	25
7 of 2240W	233.8	9.58	1.5	2.5	4	6	10	10	10	16	16	25
8 of 2880W	267.2	9.58	1.5	1.5	4	6	6	10	10	16	16	25
9 of 3200W	300.6	9.58	1.5	1.5	2.5	4	6	10	10	10	16	16
10 of 3520W	334.0	9.58	1.5	1.5	2.5	4	6	6	10	10	16	16
11 of 3840W	367.4	9.58	1.5	1.5	2.5	4	6	6	10	10	16	16

*This chart is to be used as a guide only. It based on a 320W solar panel, 33.4Vmp, 9.58 A Imp*

### **ROOF MOUNT ARRAY (NZ Only):**

Because the most common structure is a wooden frame, the panels and mounting system have no direct path to earth. In the event of lightning strike, the earth path is entirely via the combiner box.

- Install a minimum 6mm<sup>2</sup> earth strap to a ground stake.

### **GENERATOR SIZING:**

Total kW of the solar array, multiplied by 1.1 then divided by 0.8  
 = minimum kVa required from the generator.

## 6c. iSOLAR V3 Controller installation notes

### Controller and DC input power isolator

- Install the controller where it is shielded from adverse weather and out of direct sunlight. Mounting in the lee of the array or inside an additional enclosure is recommended.
- Earth the controller body to ground.

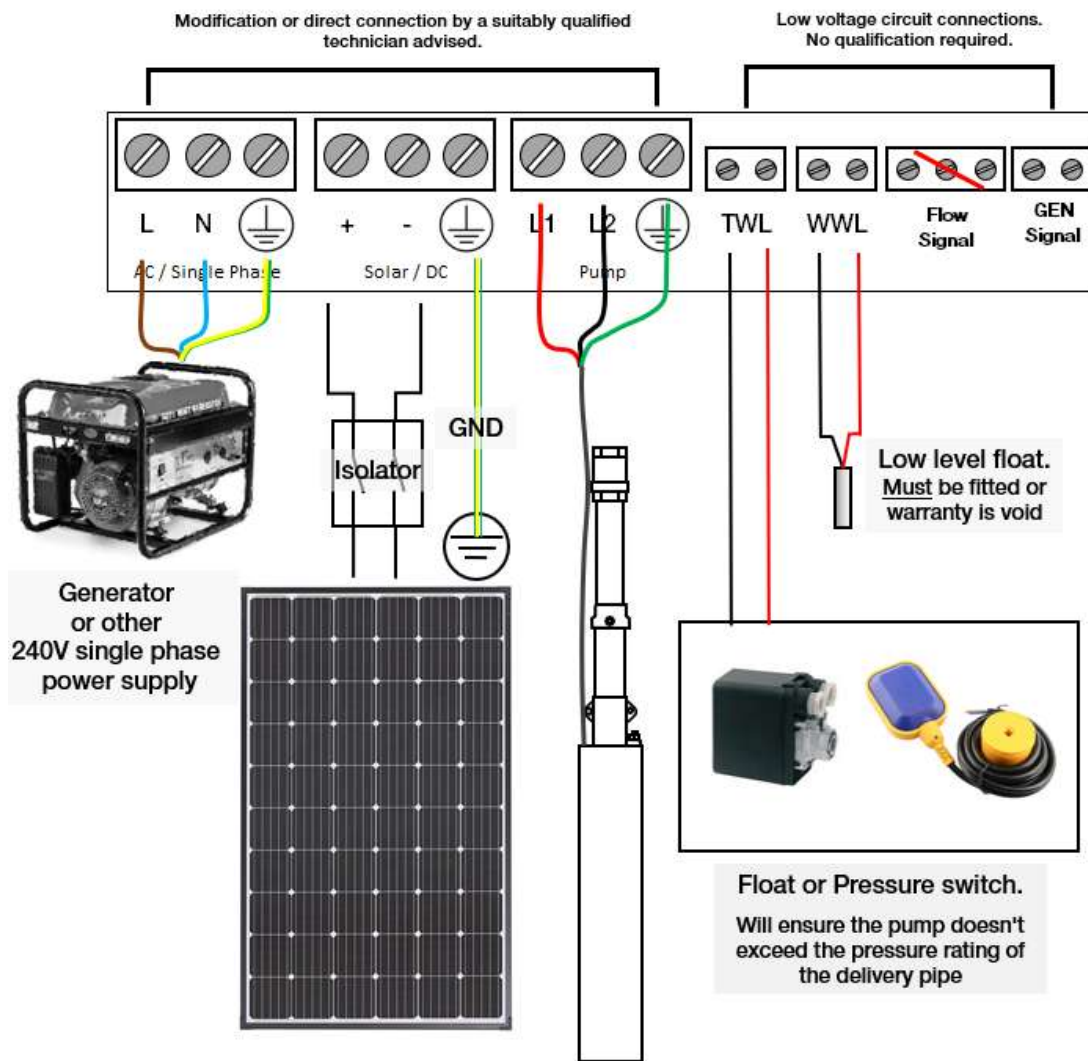

## 6d. Electrical Connections

Any electrical alterations or additional connections should be carried out by a suitably qualified technician.

Ensure the controller is isolated before removing the cover to access the low voltage circuit connections.

The controller is IP65 rated but should not be exposed to direct sunlight. Install the controller where it has excellent ventilation away from direct sunlight or exposure to adverse weather. Installation inside a separate open fronted enclosure is suggested.



## 6e. Controller Operation

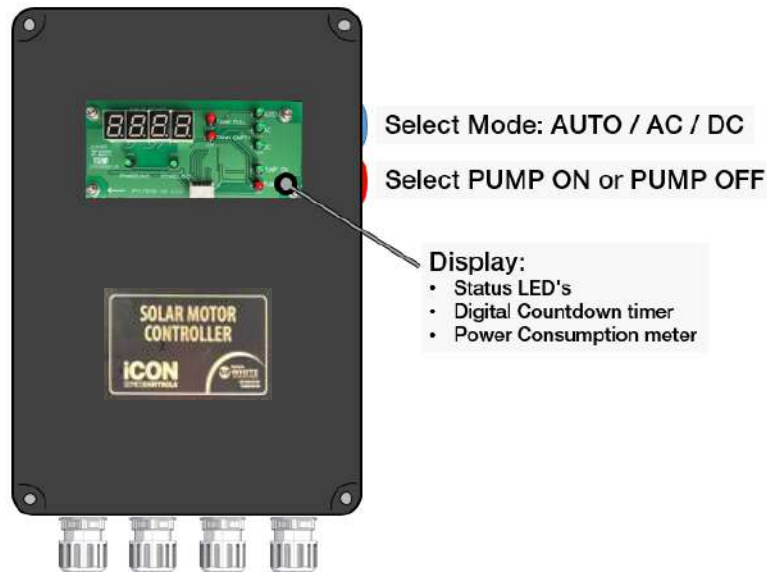

The display LEDs illuminate to indicate the available power source (1,2) the control mode (3,4,5) and the operational state (6,7)

If the low level or discharge pipe controls are active the TANK FULL (*TWL*) or TANK EMPTY (*WWL*) will illuminate

No.	Name	Function
1	Power AC	The V3 controller is connected to AC Power
2	Power DC	The V3 controller is connected to DC Power
3	Auto	The controller is in Automatic Mode with a bias to DC power. If insufficient energy is available, the controller will switch to AC mode
4	AC	The pump will run only on AC power
5	DC	The pump will run only on DC power
6	Pump On	Pump in operational mode
7	Pump Off	Pump set to inactive state

## 6f. iSOLAR PDP4 pump installation notes

White International shall not be held responsible for damage caused by improper installation, use of incorrect cable specifications, negligent or careless handling, lightning, improper voltage supply, corrosion due to impure water, wear caused by sand, gravel or other abrasives in the water being pumped.



- Only suitable qualified personnel should carry out electrical connection/disconnection
- Off-grid electrical equipment is subject to regional and national electrical standards
- The iSOLAR PDP4 motor has internal capacitors that **MUST** be allowed to discharge before handling. Allow 2 minutes for stored energy to dissipate before handling the pump/motor

The water source must be clean water free from contamination such as dirt, dust, loose rocks, decaying organic matter or any other foreign bodies that could block the intake.

Sand greater than 100g/m<sup>3</sup> will accelerate wear and shorten the lifespan of progressive cavity, helical rotor pumps such as the PDP4. Warranty does not cover failure or wear due to abrasives in the water. The stator and rotor are considered wear parts and will require replacing as pump performance diminishes with age.

### **GENERAL PRECAUTIONS**

- Never support the weight of the pump by the drop cable/safety rope or by the power cable. An unstrained safety rope must be connected to the bore pump suspended on poly pipe. This line should be fastened to the lifting hook of the pump. The other end should be fastened at the top of the bore casing/cap.
- Fit the low-level float to ensure the pump switches off should the water level reach 150mm above the pump suction inlet.  
An absent or inactive low water level float will result in damage should the pump run dry voiding warranty.
- A check valve must be installed on the pump outlet or at the well head. Additional check valves for heads greater than 80 metres may be necessary. These will reduce water hammer shocks to the pump.

### **PUMP SHROUDING**

A shroud is essential if the current drawn by the motor is above 2kW. The optimum cooling will be achieved by a water velocity of 80mm/sec past the motor.

Estimated motor consumed wattage = total wattage of the solar array and less 30%.

PDP4 minimum and maximum flows			
	Minimum (lpm)	Maximum (lpm)	Recommended flow inducer I.D to cool motor at minimum flow rate
PDP4 Solar 900	3	12	102mm ID
PDP4 Solar 900: Flow inducer sleeve optional due to low power draw			
PDP4 Solar 1200	7	25	107mm ID
PDP4 Solar 1500	11	46	112 mm ID

*Example: If the total size of the solar array is 3000W, less 30% = 2100W.  
At peak power, it is expected to be above 2kW, so fit a shroud.*

## 6f. iSOLAR PDP4 pump installation notes cont.

- For best lifespan and reliability, a vertical installation is preferred
- If installed horizontally, pump side needs to be higher than the motor
- The motor bleed hole must be in the upright position when installed



### **Borehole installations**

- Damage to pump or motor caused by abrasive or corrosive water is not covered by the Warranty.

To prevent damage to the pump by aggressive water, an analysis of the bore water should be carried out prior to installation to ensure pump suitability.

Note: Sand content not to exceed 100g/m<sup>3</sup> of water pumped

- The bore must be clean before installation. A helical pump must NEVER be used to bail a new bore. Warranty does not cover failure or wear due to abrasives in the water.
- Know the total depth of the bore and ensure that the pump does not rest on the bottom or in sand. Ensure 1.5 metres clear below the pump to the bottom of the bore.
- Know the pumping level (drawdown level) of the bore and ensure that the pump is always submerged. Minimum water level should always be 150mm above the pump inlet.

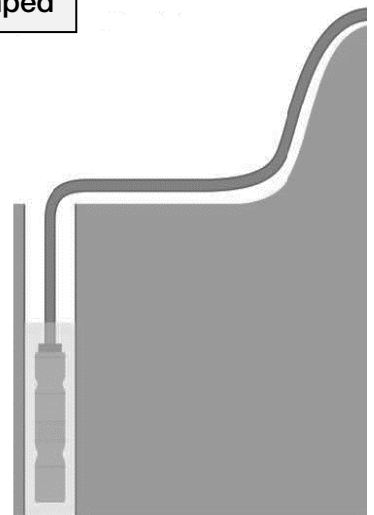

### **In-tank installations**

- The pump can be installed vertically or horizontally.
- Fit the non-return valve to the top of the pump.
- Rigid piping is recommended to prevent the pump twisting.
- Include a flushing or scour valve on the base of tank to enable periodic cleaning of the tank bottom to minimise silt build-up.
- Pump side needs to be higher than the motor – motor bleed hole must be positioned upwards to avoid airlock.



### **Pumping from an open body of water – Pond or Stream**

- Vertical installation ensures best lifespan, but it is acceptable to sling the pump horizontally.
- Ensure the water is drawn constantly from below the Water surface and without contamination.
- A simple, buoyant method of mounting the pump is to build a pontoon from PCV fittings.

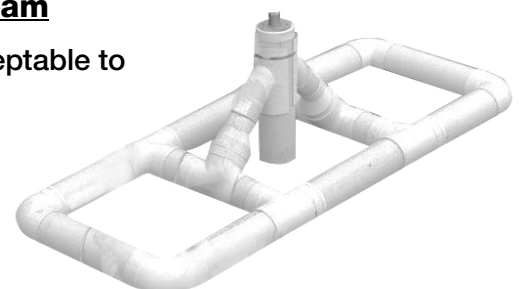

## 6f. iSOLAR PDP4 pump installation notes cont.

### **PRESSURE PIPE SELECTION**

The iSOLAR PDP has a helical rotor. This type of pump can generate extremely high pressures, particularly if they continue to operate in a no-flow / dead-head situation.



Model	Hmax	Approx. pressure Bar/PSI
PDP4 Solar 900	300m	29.41 bar / 426.6 PSI
PDP4 Solar 1200	200m	19.61 bar / 282.4 PSI
PDP4 Solar 1500	140m	13.73 bar / 199.1 PSI

- Select and use suitably pressure rated water delivery piping.
- It is **essential** to fit a switching device to the delivery line to prevent closed head operation.
- Open loop pipe systems minimise risk.

### **PRESSURE PIPE SIZING**

The iSOLAR PDP4 range has modest output flows of so the resulting pipe friction losses are low. The correct pipe sizing allows for the possibility of very long delivery piping.

The following table is a 'worst possible case' example. The pressure loss values per 100m of pipe length are for 16 bar rated pressure supply pipe at 3 flow rates.

Pipe size	Friction loss per 100m of pipe		
	10 lpm	20 lpm	40 lpm
MD 25 PN16	2.88 m	9.83 m	33.58 m
MD 32 PN16	0.90 m	3.06 m	10.47 m
MD 40 PN16	0.31 m	1.05 m	3.59 m
MD 50 PN16	0.10 m	0.36 m	1.22 m

If unsure, increasing the pipe size by one size will result in a substantial reduction to the pipe friction losses.

### **LOW VOLTAGE, LOW-LEVEL FLOAT** (dry-run protection - See Page 10.)

- The low-level float **MUST** be fitted into the WWL circuit to prevent dry running. Installing a PDP4 pump without the low-level float voids warranty.
- The low-level float must be a minimum of 150mm above the pump inlet
  - If the float shuts the pump down due to a lack of water, the LED on the controller display labelled 'TANK EMPTY' will illuminate.
  - When the water level rises the pump will restart after a 10-minute delay



### **PUMP MOTOR EARTHING**

The iSOLAR M220HR motor cable has an earth lead which **MUST** be connected to the Earth (ground circuit) of the V3 controller. If operating or testing the pump, ensure the motor is well earthed to prevent a lethal shock hazard





## 6f. iSOLAR PDP4 pump installation notes cont.

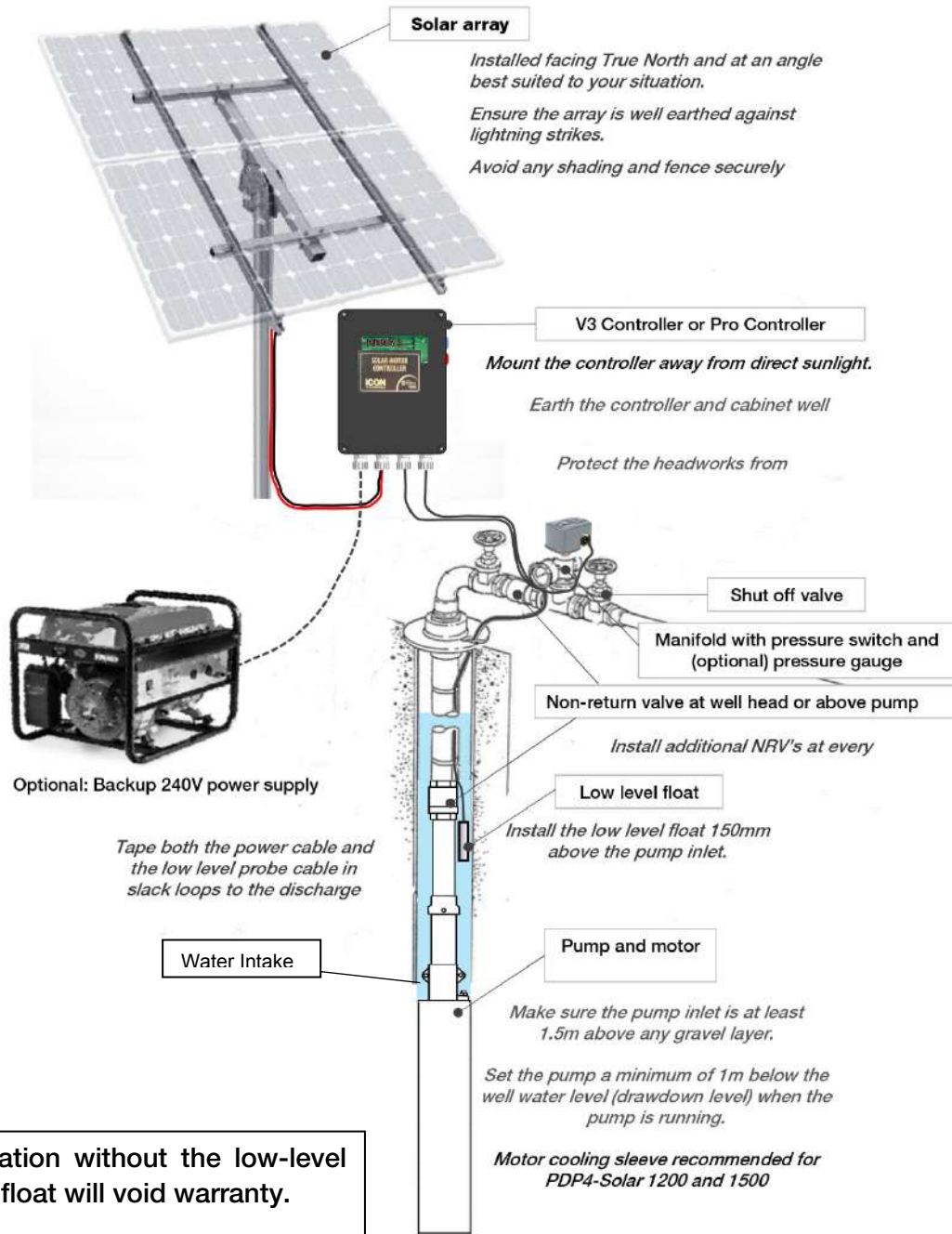

Installation without the low-level water float will void warranty.

Fitment of a pressure switch or destination float level is strongly recommended

**Maximum Pump Submergence is 150m**

Never perform insulation resistance checks using a megohmmeter as this can damage the internal motor electronics.



## 6g. Cable Jointing

Jointing kit contents:

- 4 x Item Crimp Connectors (BP025)
- 4 x Item 10mm x 60mm HEAT SHRINK TUBE with RESIN
- 1 x Item 25mm x 305mm HEAT SHRINK TUBE with RESIN

To ensure a properly sealed joint, a Heat Gun capable of  $\geq 275^{\circ}\text{C}$  is required to shrink the insulation sleeving (items 2 and 3).

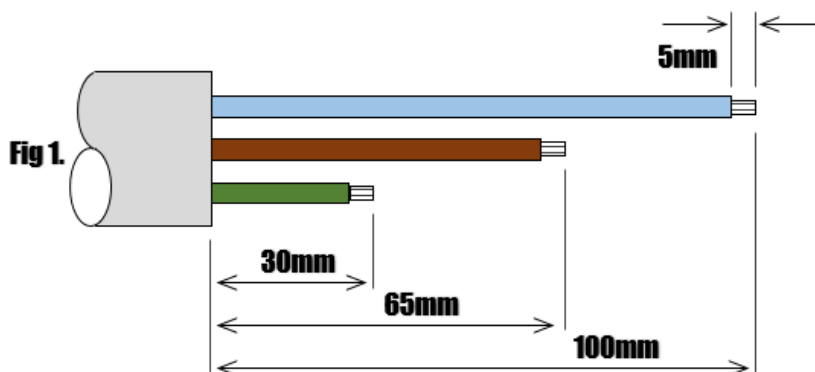

1. Remove 100mm of outer insulation from each cable to be joined, taking care not to damage secondary insulation.
2. Reduce the three wires of each cable to the dimensions shown in Fig.1, ensuring that the wire colours align as Fig.2.

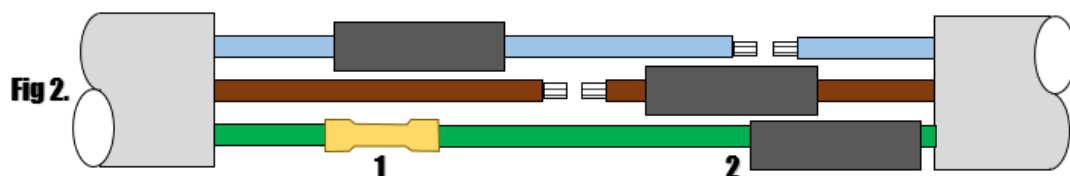

3. Slip item (3) over one end of the cable and item (2) over each of the three wires before using item (1) Crimp Connector to join wires as shown in Fig.2. Complete all crimps and locate item (2) over the completed crimps before commencing to heat shrink the individual connections.

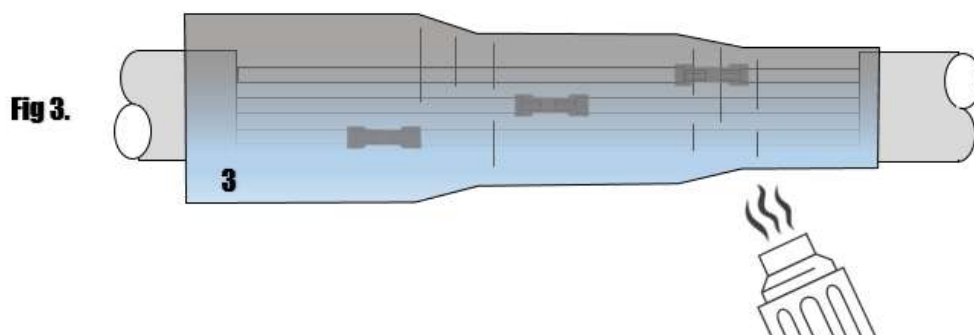

4. Locate item (3) centrally over the three wires and commence to shrink from one end as shown in Fig.3.  
When sleeving is shrunk to its maximum, the cable joint is complete.



## SECTION THREE – Pump operation

### 7a. Operation summary and commissioning

- Ensure all electrical connections are joined correctly and there are no bare wires.
- Ensure any output valves fitted to the system are open.
- Check that the pump is completely immersed,
- Check the DC input isolator is switched on.

The **POWER AC** or **POWER DC** LED will illuminate when there is energy available.



**A**

Select the mode of operation: Auto, AC or DC (upper blue button)

The **AUTO**, **AC** or **DC** LED will illuminate to indicate the selected power mode

In auto mode, the controller will select the power source to run the pump depending on input signals. Bias is always DC power source.

When the system is using AC power, the AC led light pulses in 10 sec intervals

When the system is using DC power, the DC led light pulses in 10 sec intervals

*Note – When switching between modes, the motor needs to dissipate the energy stored within the internal capacitors. This process takes 2 minutes. Repeated switching between modes restarts the dissipation cycle, causing extended delays before the pump will run.*

**B**

Press ON/OFF button to commence operation (lower red button)

The **PUMP ON** LED will illuminate.

The controller will assess the available energy. If the minimum threshold is met the controller display will count down from 120 (seconds) to dissipate any internal stored energy. This process cannot be sped up.

The controller will give a quiet click at the end of the countdown cycle and 16 seconds later the motor will attempt to run.

As the motor starts, the display will indicate the energy the motor is consuming.

## 7a. Operation summary and commissioning cont.

The internal electronics vary the pump running speed (and therefore flow output) depending on the energy available by employing MPPT and Vector control to achieve maximum efficiency.

Solar energy changes constantly especially on cloudy days. The display values will be constantly changing as the pump adjusts to optimise the output based on the available input power.

*The display value indicates what the pump is currently consuming. It is not a measure of solar array output. It is normal that the values are constantly changing.*

### Commissioning note:

It is common when commissioning a new installation that the available solar irradiation is past the peak of the day or is compromised by cloudy or otherwise poor weather

Use a generator to check the installation. If the pump runs on AC power, it will run when DC power is available.

Depending on the output of the generator vs the size of the array, the performance of the pump when connected to the generator may be greater than maximum available from the solar array. If a pressure switch is fitted to the discharge pipe it will be critical to ensure the pump can attain the switch off pressure when connected to the solar array.



**The low water level float must be installed as an interrupter in the control circuit (WWL).** Should it sense a lack of water the pump will shut down and the LED on the controller labelled 'TANK EMPTY' will illuminate.

When the water level rises again the controller will count down from 600 (seconds). The 'TANK EMPTY' LED will switch off and the pump will commence its 120sec restart cycle.



**Should the switch circuit TWL (float or pressure switch if fitted) stop the pump running, the LED on the controller labelled 'TANK FULL' will illuminate.**

When the pressure drops or float falls, the switch circuit opens again, and the controller will first count down from 600 (seconds). The 'TANK FULL' LED will switch off and the pump will commence its 120sec restart cycle.



**To suspend operation, press ON/OFF.**

The PUMP OFF LED will illuminate.

## SECTION FOUR – Troubleshooting

### 8a. Trouble shooting - Overview

Isolate all electrical sources before commencing any installation, servicing, or repair on any component in the installation.



The iSOLAR PDP4 motor has internal capacitors that **MUST** be allowed to discharge before handling. Allow 2 minutes for stored energy to dissipate before handling the pump/motor.

The V3 Controller is used to switch AC and DC power supplies and can automatically start a connected generator or switch between DC (Solar) or AC (Generator / Mains) power sources at ANY time.

Ensure all energy sources and generator starting circuit is properly locked-out before working on the system.



---

**For the end-user, their expectation of how the pump should operate is often based on conventional electric pumping systems.**

In normal operation the iSOLAR M220HR motor is an ever-changing device as it constantly adjusts itself to optimise the available power to maximise water delivery.

Every application is different, every power combination has an effect and environmental conditions change how the pump operates. On sunny windy days with clouds blowing by the pump operation can be positively erratic.

It may be that the 'strange behaviour' observed is simply the pump optimising the available energy.

**The best indication that there is a problem is if the water delivered per day is dramatically less than normal.**

Take the time to read the following information to gain an all-important understanding of how the pump and controller are intended to operate.

#### **Motor Internal electronics**

The electronics inside the motor monitor current, rpm and electrical load. They adjust the motor *according to the input power available*.

If there is insufficient power for the motor to reach its target speed range (0 – 3600 rpm) then the motor will shut down and begin its start-up cycle again.

Just because 'the sun is shining' does not automatically guarantee there is sufficient solar energy for the pump to run, particularly early or late in the day.

If for example, the day is overcast, the pump may struggle to reach its optimum operating range. The motor may have sufficient voltage but the overall wattage is too low to run the motor at the necessary head so the motor will shut down and restart until the power is stable. The same behaviour occurs if there is excessive start-up torque.

## 8a. Trouble shooting – cont.

The motor does not know specifically why it is unable to run. Its internal programming is intended to protect the pump should it be unable to operate within its safe duty range.

External factors such as insufficient flow (water starvation, excessive head/torque, or other blockages) can also cause the motor to shut down so check entire system to ensure the issue is not related to valving or piping etc.

### V3 Controller

The controller does not directly contribute to the behaviour of the motor once it is running. Rather the controller monitors the power available from the solar array and adds a greater level of protection by allowing various control inputs (low level float and discharge pipe pressure switch or destination float).

Section 7a, Pages 17 and 18 explains the start and stop procedures. The LED's on the display provide visual indication as to the operational state of the controller/motor.

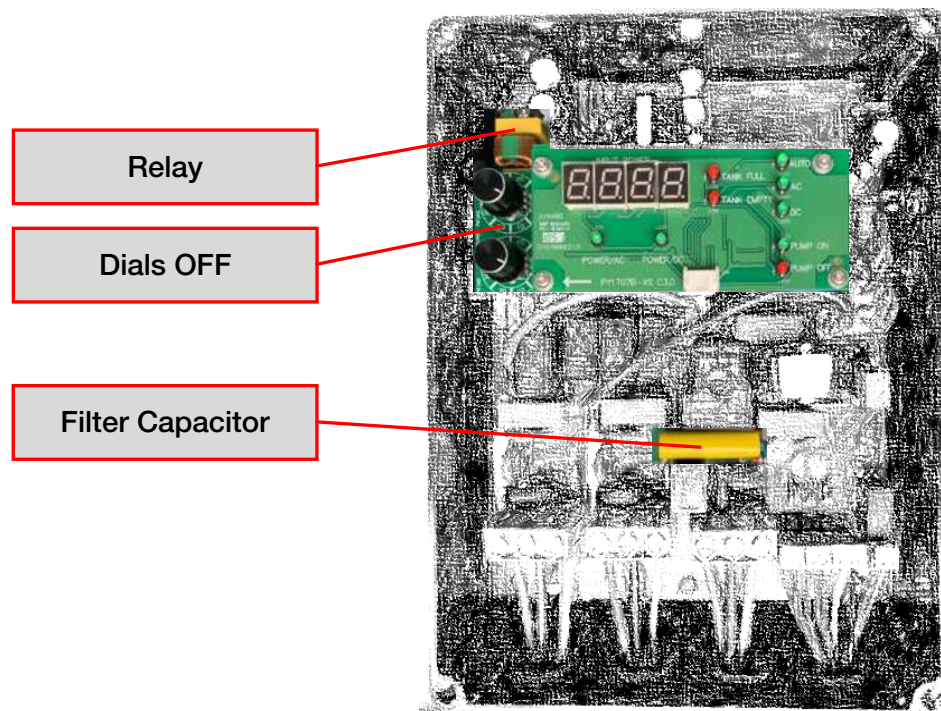

- Check there is enough power at the controller (available Voltage and Amperage)
- Check for loose or poor DC voltage connections
- Check the inputs to the solar controller  
To isolate the inputs - bridge the TWL (closed). Leave WWL open.

To eliminate the V3 iSOLAR controller as a possible cause of any unusual behaviour, have a suitably qualified person connect the energy input from the solar array (DC) or from a 240V AC power source directly to the motor.

## 8a. Trouble shooting – cont.

### DC power is locked on:

- Check signal on display
- Does pump operate when controller is in **POWER OFF** mode?  
If so, this may be caused by a fused relay.

### Pump in Run mode and power on site but pump still does not operate:

- Check input Voltage passes through to motor. A faulty filter capacitor may be blocking the current.

Rather than focus excessively on the controller, remember that you are just dealing with a bore-pump, so check all elements of the system.

### Motor not producing enough flow:

- Is the Pump completely submerged in operation (false dry run)?
- Is the water depleting too quickly?
- Ensure the pump inlet is clean and there is no clogging

### Motor will not start:

- Does DC supply exceed maximum or minimum requirements?  
**(Max: 440VDC Voltage Open Circuit, Max Short circuit current 12A DC)**
- Does AC power exceed maximum 280V?  
**(Max Short circuit current 10A AC)**

Check the panels for any damage or shading. Shade, bird droppings or dust on a single panel will compromise the output of the whole array.

Check pump operation by connecting a generator.

With a generator supplying maximum 240V 10A, the motor will run at its maximum output.

*Note: A system which is undersized or requires excessive power compared to the design duty will sometimes deliver water on a generator but not on DC power.*

If the motor is experiencing excessive load it will reduce its power consumption and shut down. Ensure the pump inlet is clean and not blocked. Insufficient flow due to a blocked inlet or a blocked discharge can cause the pump to shut down.

Remove the motor from the wet-end. The motor shaft should have considerable resistance to rotation due to the internal magnetism of the motor.

**A motor which can be rotated freely by hand (no resistance) has lost its magnetism and should be serviced or replaced.**

## 8b. Trouble shooting chart

Problem	Possible cause
Pump does not start	Faulty pressure switch Control box in sun or near heat source Defective Hydraulic overload Low voltage supply to motor (low solar irradiation) iSOLAR V3 controller switching between energy sources
No water delivered	Low solar irradiation Water level too low in well Inlet clogged Broken pump shaft or coupling Check valve installed backwards Check valve stuck closed Hole in delivery pipe below top of bore
Poor water delivery	Fittings stopping check valve opening fully Water level too low in well Discharge pipe clogged, corroded or ruptured Pump installed too low in well and covered with sand or other solids Inlet screen partially clogged Worn pump Leak in outlet pipe below top of bore Check valve stuck partially closed
Pump does not shut off	Pipe ruptured Defective or improperly adjusted pressure switch Water level too deep for pump. Check selection Pump is air or gas bound Worn pump Pipe obstruction
Pumps starts more than ≥ 5 starts per hour	Incorrect pressure switch setting. Pressure switch differential adjustment failure
Electric shock from water pipe	Defective (grounded) incoming power leads Defective control box Earth wire connected to wrong control box terminal <i>Note: A motor down to earth or defective cable will not cause a shock.</i>
Pressure gauge oscillates, flow surges (snoring)	Water level too low in the well. (Flow through pump greater than flow into well)
Electrolysis on motor and pump	Insufficient earth / earth leakage Broken earth wire

**NOTE:** Always install borehole submersibles with ON/OFF switches and approved circuit breaker(s) to protect against motor damage and electrocution

### Warranty:

To be assessed for possible warranty, the motor must be returned with cable and joint intact. White International require the cable be cut at least 100mm above the cable joint.

**If more assistance is required, contact White International**



## 9. Warranties – Terms and Conditions



This warranty is given in addition to the consumer guarantees found within the Australian Competition and Consumer Act 2010 (Cth) for goods purchased in Australia and the Consumer Guarantees Act 1993 NZ for goods purchased in New Zealand:

1) White International Pty Ltd / White International NZ Ltd (White International) warrant that all products distributed are free from defects in workmanship and materials, for their provided warranty period as indicated on the top or opposite side of this document. Subject to the conditions of the warranty, White International will repair any defective products free of charge at the premises of our authorised service agents throughout Australia and New Zealand if a defect in the product appears during the warranty period. If you believe that you have purchased a defective product and wish to make a claim under this warranty, contact us on our Sales Hotline on 1300 783 601, or send your claim to our postal address or fax line below and we will advise you as to how next to proceed. You will be required to supply a copy of your proof of purchase to make a claim under this warranty.

2) This warranty excludes transportation costs to and from White International or its appointed service agents and excludes defects due to non-compliance with installation instructions, neglect or misuse, inadequate protection against the elements, low voltage or use or operation for purposes other than those for which they were designed. For further information regarding the suitability of your intended application contact us on our Sales Hotline on 1300 783 601. If you make an invalid claim under this warranty, the original product will be sent back to you unrepaired.

3) This warranty refers only to products sold after the 1st January 2012, and is not transferable to another product type and only applies to the original owner, purchaser or end user, and is in addition to the consumer guarantees found within the Competition and Consumer Act 2010 (Cth) for goods purchased in Australia and the Consumer Guarantees Act 1993 (NZ) for goods purchased in New Zealand.

4) Our goods come with guarantees that cannot be excluded under the Australian Consumer Law. You are entitled to a replacement or refund for a major failure and for compensation for any other reasonably foreseeable loss or damage. You are also entitled to have the goods repaired or replaced if the goods fail to be of acceptable quality and the failure does not amount to a major failure. **2 YEAR WARRANTY**

5) To the fullest extent permitted by law, White International excludes its liability for all other conditions or warranties which would or might otherwise be implied at law. To the fullest extent permitted by law, White International's liability under this warranty and any other conditions, guarantees or warranties at law that cannot be excluded, including those in the Competition and Consumer Act 2010 (Cth), is expressly limited to: (a) in the case of products, the replacement of the product or the supply of equivalent product, the payment of the cost of replacing the product or of acquiring an equivalent product or the repair of the product or payment of the cost of having the product repaired, is at the discretion of White International or a 3rd party tribunal elected under the Competition and Consumer Act 2010 (Cth) for goods purchased in Australia and the Consumer Guarantees Act 1993 (NZ) for goods purchased in New Zealand; and

6) To the fullest extent permitted by law, this warranty supersedes all other warranties attached to the product or its packaging.

7) In the case of services, supplying the services again or the payment of the cost of having the services supplied again, is at the discretion of White International or a 3rd party tribunal elected under the Competition and Consumer Act 2010 (Cth) for goods purchased in Australia and the Consumer Guarantees Act 1993 (NZ) for goods purchased in New Zealand. 8) Our warranty commences from the date of purchase of the above-mentioned pumps. Proof of purchase is required before consideration under warranty is given.

*Record your date of purchase in the space below and retain this copy for your records.*

**Date of Purchase .....****Model Purchased .....**



**[www.whiteint.com.au](http://www.whiteint.com.au)**

**1300 783 601**

**[www.whiteint.co.nz](http://www.whiteint.co.nz)**

**0800 509 506**

**Please always refer to our website for further technical information & new product innovations**

**Disclaimer:** Every effort has been made to publish the correct information in this manual. No responsibility will be taken for errors, omissions or changes in product specifications.

© 2020 Copyright White International Pty Ltd

TM ® - WARNING: Please be aware that various brands & products depicted within this document are subject to trademark, patent or design registrations. Infringement of any intellectual property contained within this document without express written authority by the appropriate intellectual property holder may result in further legal action to be taken. For any queries regarding use of the contained information please feel free to contact White International Pty Ltd.